

Technical data sheet

Vers. US-0/2024



This document has been designed to provide guidelines and helpful suggestions for the processing of Lapitec® slabs.

The information contained herein reflects the highest level of technical/scientific and operational knowledge in possession of the manufacturer at the time of publication. You are therefore invited to consult the latest updated version in the “catalogues” section of the website www.lapitec.com where the following documents can be found:

- Technical data sheet;
- Processing manual;
- Design and installation manual for kitchen countertops;
- Design and installation manual for claddings;
- Design and installation manual for ventilated facades.

Given that Lapitec is a natural sintered material, the user is advised not to limit themselves to the instructions provided in this document, but rather to consult the extensive technical/scientific and operational literature available on the subject, and to rely on professional experts for the various processing and installation phases.

Regarding the above, Lapitec S.p.A. shall not be held liable for any damage which may occur as a result of the application of the information and suggestions in this technical manual, insofar as considered information and suggestions that must always be checked in advance by the user.

Moreover, Lapitec S.p.A. reserves the right to make technical changes of any kind without prior notice and without direct communication to any party.

INDEX

1.	LAPITEC SINTERED STONE	5
1.1.	DESCRIPTION	5
1.2.	COLOURS AND FINISHES	6
1.3.	TECHNICAL CHARACTERISTICS	8
1.4.	SILICA FREE	10
1.5.	PLUS LAPITEC	11
1.6.	SLAB DIMENSIONS	12
1.7.	SLAB TOLERANCES	13
1.7.1	PLANARITY	13
1.7.2	THICKNESS	14
1.7.3	GLOSS GRADES	14
1.7.4	SHADE DIFFERENCES	15
1.7.5	AESTHETIC CONFORMITY	16
1.8.	CHOICE OF FINISH	17
1.8.1	SLIPPERINESS	17
1.8.2	EASE OF CLEANING	19
1.9.	IDENTIFICATION LABEL	20
1.10.	TESTING AND CERTIFICATIONS	20
1.11.	CUT TO SIZE	21
1.11.1	MODULAR FORMATS	21
1.11.2	WORKPIECES TOLERANCES	22
2.	PACKAGING AND HANDLING	24
2.1.	PACKAGING	24
2.1.1	WOODEN BUNDLE	24
2.1.2	WOODEN A-FRAME	28
2.1.3	PAIRS OF STEEL A-FRAMES	32
2.1.4	NON-STANDARD PACKAGING: CRATES, PALLETS, ETC.	34
2.2.	HANDLING OF SLABS	36
2.2.1	MANUAL HANDLING	36
2.2.2	HANDLING WITH EQUIPMENT	36
2.3.	SLAB INSPECTION	37
3.	CUSTOMER CARE	40



1. LAPITEC SINTERED STONE

1.1. DESCRIPTION

Lapitec® is a sintered stone: an innovative material produced in large slabs using exclusive, patented technology, which can be used both indoors and outdoors.

Lapitec sintered stone is resistant to wear and tear, weather conditions, UV rays, heat, and frost, as well as being non-porous. Lapitec offers a number of different surface finishes, making it the perfect solution for both flooring and wall cladding.

The various surface finishes of Lapitec make it suitable for use both on floors and walls. Lapitec is compatible with a wide range of adhesives and fixatives, allowing its installation on supports of various kinds.

Standard dimensions

135 1/2" x 60 5/8" for slabs with a thickness of 1/2" and 3/4".

133 3/4" x 59" for 1 1/4"-thick slabs.

Thicknesses

1/2"

3/4"

1 1/4"

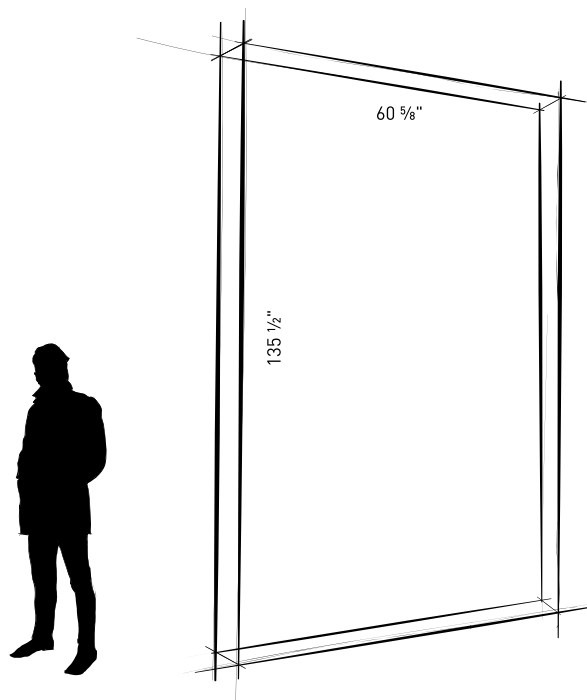

1.2. COLOURS AND FINISHES

Essenza Collection

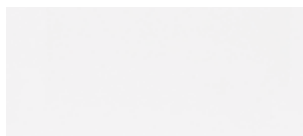

BIANCO ASSOLUTO

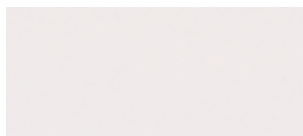

BIANCO POLARE

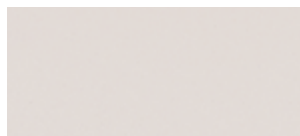

BIANCO CREMA

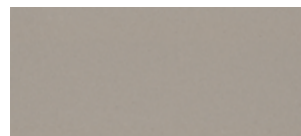

TERRA AVANA

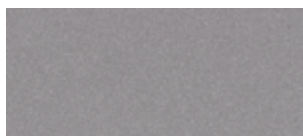

GRIGIO CEMENTO



NERO ANTRACITE

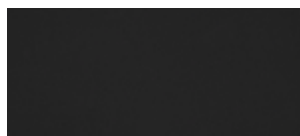

NERO ASSOLUTO

Musa Collection



BIANCO VITTORIA

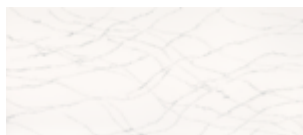

BIANCO GIULIA



BIANCO SERENA



BIANCO ANDROMEDA

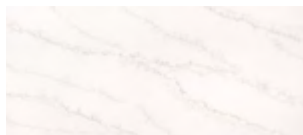

BIANCO ANGELICA

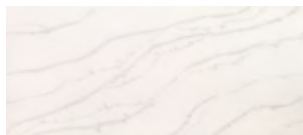

BIANCO OLIMPIA



BIANCO ATENA



BIANCO PANDORA



BIANCO DIANA



BIANCO ALBA

Finishes

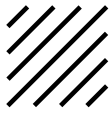

LUX



The high-gloss surface of the slab adds brightness to the material, really enhancing the surroundings where it is installed.

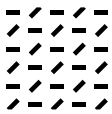

SATIN



A sophisticated matt look that is soft to the touch, bringing to mind the texture and elegance of silk.

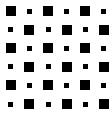

LITHOS*



A surface with subtle wrinkles, offering different sensations with every touch and a colour effect with soft and natural shades.



VESUVIO*



Structured, soft and dynamic to the touch, with a movement that gives the surface strength and vitality, reducing any slipperiness.

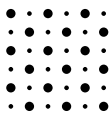

ARENA*



A smooth, sandblasted finish, featuring an even grain that creates a sense of natural dynamism along the entire slab, giving each colour a lighter and richer shade.

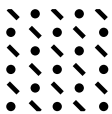

VELLUTO























Velluto is a full-bodied satin finish, suitable for both indoor and outdoor applications. Its texture is very versatile and soft to the touch.

* Structured finish

N.B.: please contact the company for any technical information regarding finishes that are no longer in production.

1.3. TECHNICAL CHARACTERISTICS

Technical characteristics		Standard	Test result
	Standard dimensions	EN 14617-16	135 1/2" x 60 5/8" (1/2"-3/4") 133 3/4" x 59" (1 1/4")
	Thicknesses	EN 14617-16	1/2" - 3/4" - 1 1/4"
	Specific weight	EN 14617-1	2,4÷2,53 kg/dm ³
	Water absorption	EN 14617-1	0.02%
	Flexural strength	EN 14617-2	44 MPa
	Deep abrasion resistance	EN 14617-4	29 mm
	Mohs hardness	ASTM C1895-20	7
	Frost and thaw resistance	EN 14617-5	95%
	Thermal shock resistance coefficient	EN 14617-6	-3,7%
	Impact resistance	EN 14617-9	1.1 Joule (1/2") 2.68 Joule (3/4")

Technical characteristics		Standard	Test result
	Resistance to chemical substances	EN 14617-10	C3 - Resistant
	Coefficient of linear thermal expansion	EN 14617-11	$5.8 \times 10^{-6} \text{ } ^\circ\text{C}^{-1}$
	Dimensional stability	EN 14617-12	A
	Fire reaction	EN 13501-1	A1
	Thermal conductivity	EN 15285	0.023W /mK
	Specific heat	EN ISO 10456	840 J/kgK
	Resistance to the diffusion of water vapour	EN ISO 12572	3.88×10^4
	Non-slip properties	Miscellaneous	Please refer to the dedicated section in this manual
	Compressive strength	ASTM C170	493 MPa Dry 493 MPa Wet
	Colour lightfastness	DIN 51094	No change
	Water absorption - due to capillarity	EN 1925	$0,006 \text{ g/m}^2\text{s}^{0,5}$

Lapitec is a fireproof material with 'A1' classification. It does not catch fire if exposed to flames, it does not release smoke and it is flame retardant.

Extreme temperature fluctuations, such as direct exposure to a flame, may cause the material to break.

1.4. SILICA FREE



Biorite® is a patented mineral, non-toxic and crystalline-silica-free, obtained with a particular melting process at about 2912 ° F, starting from a unique blend of 100% natural mineral powders.

Lapitec slabs produced using Biorite can be considered “Silica free” as they contain a crystalline silica percentage that does not exceed 1%.

Biorite is produced exclusively at the Lapitec plant in Vedelago. This allows for a comprehensive control of the raw materials and the production cycle, further improving the consistency of the technical and surface characteristics of the slabs.

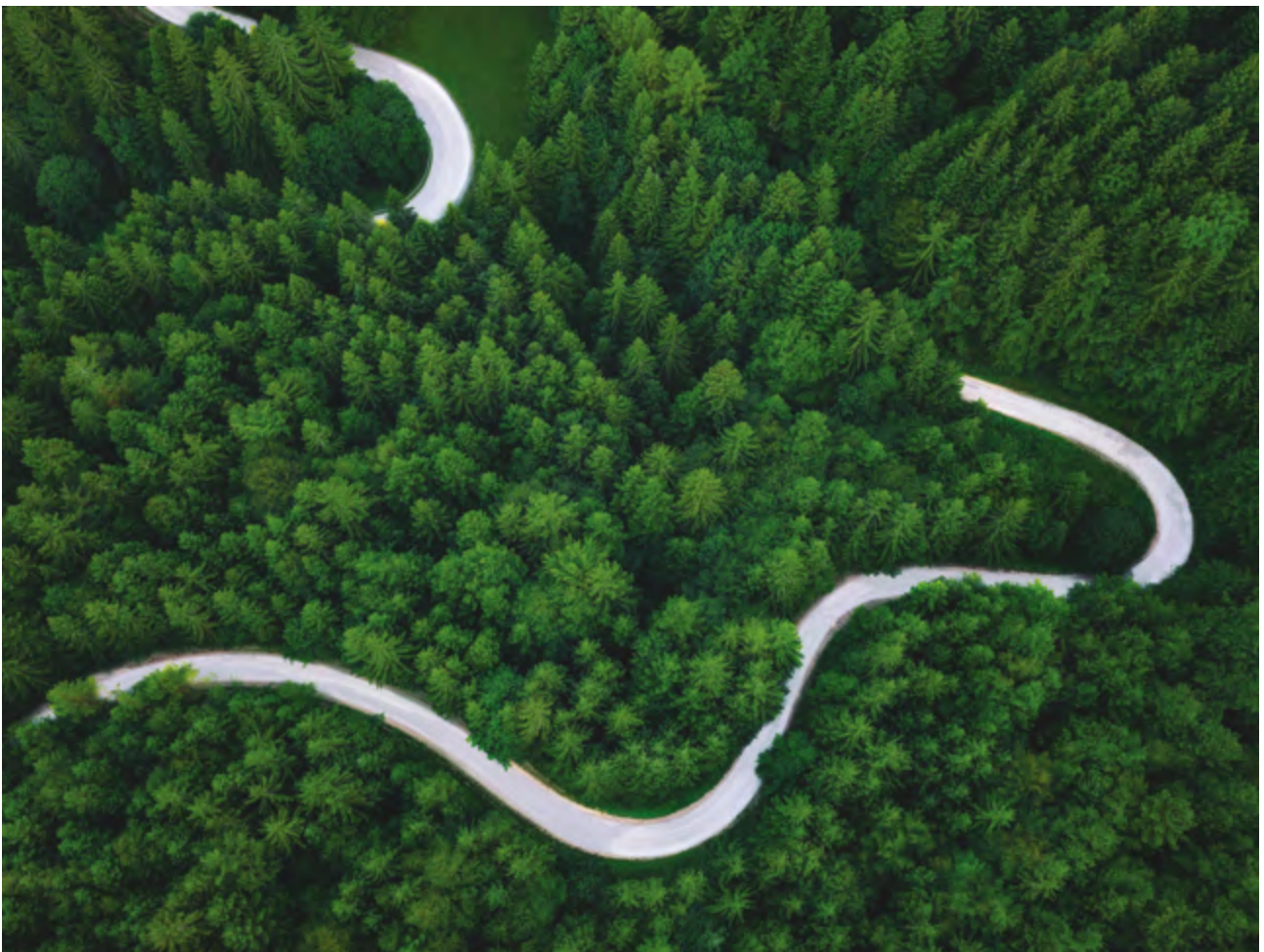

1.5. PLUS LAPITEC

Hygienic and antibacterial

Prevents the proliferation
of germs and microbes



Heat resistant

Resistant to
high temperatures



Easy to clean

Non porous
and stain resistant



UV stable

Colour unaffected
by sunlight



Green

Not printed
and 100% natural



Chemical resistant

Unaffected by alkaline
or acidic products



Scratch resistant

High resistance
against scratching



Frost resistant

Resistant to
low temperatures



1.6. SLAB DIMENSIONS

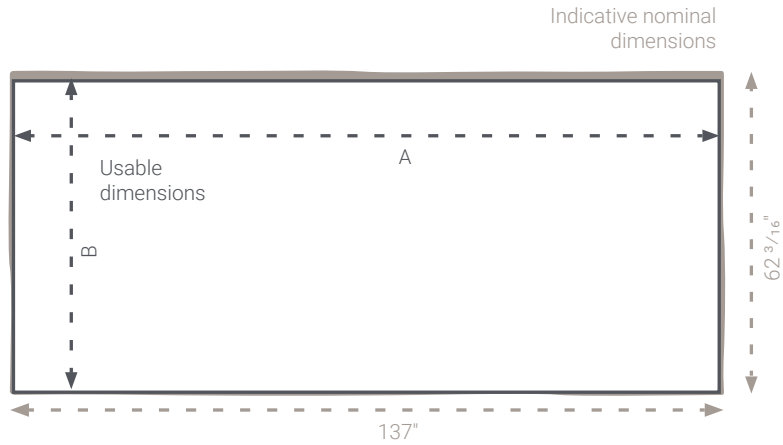

	Full slab dimensions	1/2" slab usable area	3/4" slab usable area	1 1/4" slab usable area
length (inches)	137	135 1/2 (A)	135 1/2 (A)	133 3/4 (A)
width (inches)	62 ³ / ₁₆	60 ⁵ / ₈ (B)	60 ⁵ / ₈ (B)	59 (B)

Technical information	U.M.	1/2" (mm)	3/4" (mm)	1 1/4" (mm)
Full slab surface area	ft ²	59.2	59.2	59.2
Slab usable surface area	ft ²	57	57	54.9
Weight per ft ²	lb/ft ²	6.5	10.2	14.9
Slab weight	lb	385.8	606.3	881.8

Slab weights and dimensions are indicative.

1.7. SLAB TOLERANCES

1.7.1 PLANARITY

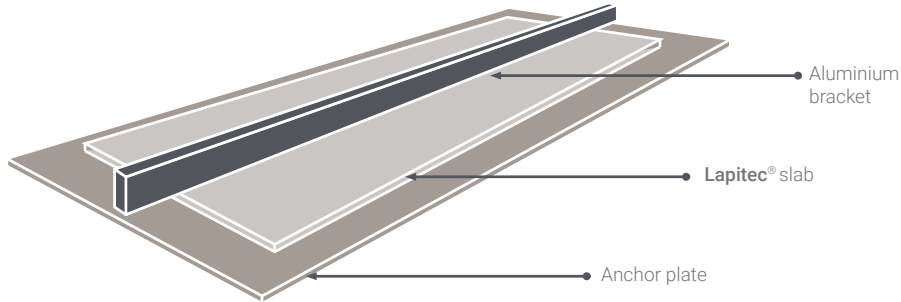

Thicknesses (inches)	Transversal		Longitudinal	
	Length (inches)	F (inches)	Width (inches)	F (inches)
1/2-3/4-1 1/4	60 5/8	≤1/16	135 1/2	≤9/64

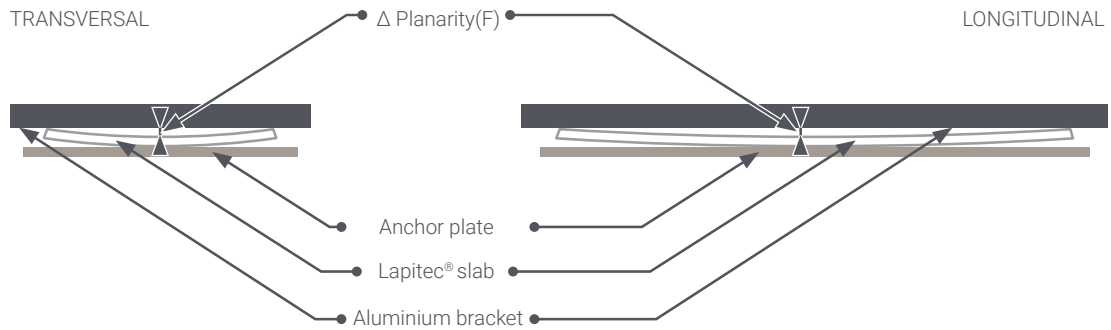

In order to correctly measure planarity, the slab must be resting on a perfectly horizontal and stable anchor plate; it is therefore necessary to avoid A-frames or measurements when the slab is suspended. Planarity is measured using an aluminium bar and thickness gauges to the centre of each side: 29 1/2" and 67".

1.7.2 THICKNESS

Nominal thickness (inches)	Tolerance (inches)	H1 (inches)
1/2	-0 / +1/32	< 3/32"
3/4	+/- 1/64	< 3/32"
1 1/4	+/- 1/64	< 3/32"

SMOOTH SURFACE

STRUCTURED SURFACE*

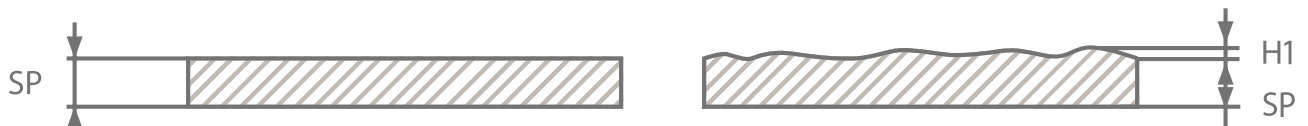

* STRUCTURED SURFACES: finishes with a structured surface are specified in the "COLOURS AND FINISHES" section.

1.7.3 GLOSS GRADES

Finish	GLOSS	
	Gloss	Changes in gloss in the same slab
Lux	> 65	< 10
Satin	< 20	< 3
Vesuvio	< 5	< 3
Arena	< 6	< 3
Lithos	< 7	< 3
Velluto	< 16	< 3
Meridio	< 10	< 3

Gloss grades are measured using a glossmeter on the finished surface. Any gloss variations on the same slab are checked by taking recordings along the sides and in the centre of the slab itself.

1.7.4 SHADE DIFFERENCES

Lapitec is suitable for installation on large surfaces such as façades, paving and cladding in general. The Lapitec production process involves sinterisation at over 2192°F, creating slabs that are characterised by minimal shade differences.

With the aim of managing even only the slightest shade differences, Lapitec S.p.A.'s R&D department has developed a special device able to accurately measure and record the colour of each slab, reporting the result in the relative QR Code printed on the label.

International standards (CIElab2000) allow for shade differences between two slabs, of the same colour and finish, to be compared, using a unique parameter called ΔE (delta "e").

In architectural applications (façades, paving, etc.), an adequate level of compatibility is achieved when the shade difference between two contiguous elements is very low, normally characterised by a ΔE of less than or equal to 1. In order to ensure a high level of quality, Lapitec S.p.A. is able to supply identified batches of slabs with a ΔE of less than or equal to 1.

App

To make it easier to manage the different shades available, Lapitec S.p.A. has developed an exclusive multilingual app for Android and Apple smartphones and tablets, allowing you to check any shade differences for a group of slabs, by simply scanning the relative QR Code on their labels. This makes it possible to check whether the slabs supplied can be used together, or also with those in the warehouse.

Please note that the QR Code was introduced starting from slabs identified with numbers higher than 01000000167000. Customers may nonetheless ask Lapitec to check the shades of slabs without a QR Code (with ID numbers lower than 01000000167000), by simply confirming the serial number of the slabs to be checked.

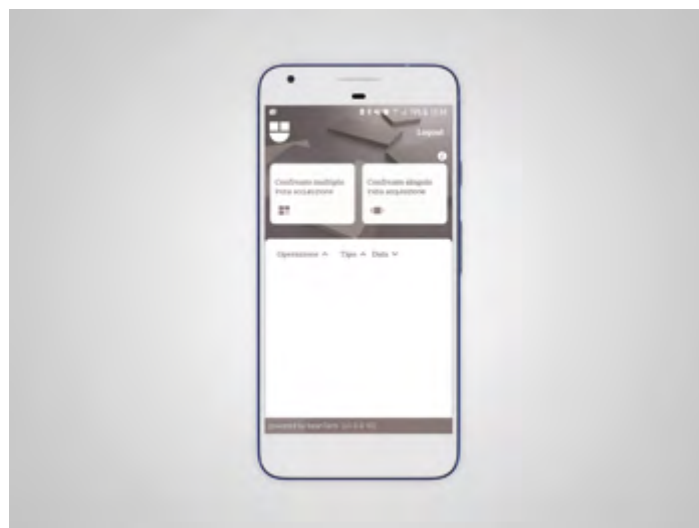

1.7.5 AESTHETIC CONFORMITY

Type of non-conformity	Dimensions (inches)
Different coloured spot	> 1/32
Uneven area	> 1/8
White grains on a dark background	> 3/64
Similar coloured spot (Lux, Satin)	> 3/16
Hole (Lux, Satin)	> 1/32
Scratch/shading (Lux, Satin)	If visible perpendicularly to the slab, from one metre away, in natural light

Note: For the colour Bianco Assoluto the size tolerance is reduced to $\leq 1/32$ for white grains on a black background and for black grains on a white background.

We recommend that our customers carefully clean and inspect each slab before use. This ensures that the product can be used in the best way possible and allows for checks into compliance with all quality standards.

Please note: this should be standard practice. Complaints will not be accepted regarding material that has been installed with defects that were already present at the time of delivery.

1.8. CHOICE OF FINISH

Selecting the right finish involves carefully considering how Lapitec is going to be used, whether for a kitchen worktop, floor, wall, etc.

It is therefore necessary to take all the various aspects into consideration, such as personal taste, non-slip properties and ease of cleaning once installed.

1.8.1 SLIPPERINESS

When designing a floor, the finish must be chosen based on the non-slip performance of the surface. It is necessary to assess how the floor will be used, the surroundings and the weather conditions in the place where it will be installed; however, above all, it is necessary to check the applicable local legislation.

There are different criteria to assess non-slip properties. Please find below a list of some of the reference legislation and the relative classifications.

Antislip performances

Regulation	Definition	Index	Lux	Satin	Lithos	Vesuvio	Arena	Velluto	Dune	Fossil	Meridio
DM236/89 BCRA	BCRA Coefficient of Friction	DCOFd average value	0,7	0,59	0,53	0,58	-	0,59	0,57	0,86	0,64
		DCOFw average value	0,6	0,48	0,61	0,48	-	0,65	0,53	0,79	0,62
DIN 51130	Anti-slip testing of floor coverings - Shod feet	Group of anti- slip properties	-	-	R10	R10	-	-	R10	R13	R11
DIN EN 16165:2021-12 - Ax B	Slip resistance of pedestrian surfaces - Shodfoot ramp	Group of anti- slip properties	-	-	-	-	R11	-	-	-	-
DIN 51097	Anti-slip testing of floor coverings - Bare feet	Classification	-	-	A+B	A+B+C	-	A	A+B	A+B+C	A+B+C
ANSI A137.1:2012 / A326.3:2017	Tile slip test	DCOFw	0,25	0,46	0,46	0,5	-	0,43	0,42	0,71	0,66
UNI EN 14231:04	Slip resistance by means of the pendulum tester	DCOFd - USRV	73	61	84	89	-	58	65	81	109
		DCOFw -USRV	17	20	34	30	-	38	28	64	62
BS 7976/02+A1:2013 United kingdom	Pendulum testers. Method of operation	DCOFd - PTV ₉₆	38	42	48	55	-	48	53	-	60
		DCOFw - PTV ₉₆	16	24	43	50	-	38	28	-	49
UNE 41901:2017 EX	Unpolished and Polished slip/skip resistance	DCOFw	25	30	55	42	-	38	31	-	60

Warning: The values shown above are average values that may vary slightly between different batches.

1.8.2 CLEANABILITY

After verifying the compatibility of the chosen finishes with the required slip resistance for the intended use of the surface to be covered, it is also important to consider the cleanability of the finishes.

Please refer to the following table for suggestions on the preferred color/finish combination based on the intended use and operating conditions (highlighted in green).

		Esenza Collection							Musa Collection
		Bianco Assoluto	Bianco Polare	Bianco Crema	Terra Avana	Grigio Cemento	Nero Antracite	Nero Assoluto	Whites with veins***
Kitchen	Kitchen countertop and backsplash ⁱ	L S H P V A	L S H P V A	L S H P V A	L S H P V A	L S H P V A	L S H P V A	L S H P V A	L S H P V A
	Reconstructed sink	L S H P V A	L S H P V A	L S H P V A	L S H P V A	L S H P V A	L S H P V A	L S H P V A	L S H P V A
Bathroom	Bathroom counter and sink	L S H P V A	L S H P V A	L S H P V A	L S H P V A	L S H P V A	L S H P V A	L S H P V A	L S H P V A
	Shower tray	L S H P V A	L S H P V A	L S H P V A	L S H P V A	L S H P V A	L S H P V A	L S H P V A	L S H P V A
Residential coverings	Indoor flooring ⁱ	L S H P V A	L S H P V A	L S H P V A	L S H P V A	L S H P V A	L S H P V A	L S H P V A	L S H P V v
	Outdoor flooring* ⁱ	L S H P V A	L S H P V A	L S H P V A	L S H P V A	L S H P V A	L S H P V A	L S H P V A	L S H P V A
	Interior wall ⁱ	L S H P V A	L S H P V A	L S H P V A	L S H P V A	L S H P V A	L S H P V A	L S H P V A	L S H P V A
	Facciata esterna ⁱ	L S H P V A	L S H P V A	L S H P V A	L S H P V A	L S H P V A	L S H P V A	L S H P V A	L S H P V A
Commercial coverings	Indoor floor ⁱ	L S H P V A	L S H P V A	L S H P V A	L S H P V A	L S H P V A	L S H P V A	L S H P V A	L S H P v A
	Outdoor floor ⁱ	L S H P V A	L S H P V A	L S H P V A	L S H P V A	L S H P V A	L S H P V A	L S H P V A	L S H P V A
	Interior wall ⁱ	L S H P V A	L S H P V A	L S H P V A	L S H P V A	L S H P V A	L S H P V A	L S H P V A	L S H P V A
	Exterior facade ⁱ	L S H P V A	L S H P V A	L S H P V A	L S H P V A	L S H P V A	L S H P V A	L S H P V A	L S H P V A
Pool and spa	Floor ⁱ	L S H P V A	L S H P V A	L S H P V A	L S H P V A	L S H P V A	L S H P V A	L S H P V A	L S H P V A
	Submerged cladding ⁱ	L S H P V A	L S H P V A	L S H P V A	L S H P V A	L S H P V A	L S H P V A	L S H P V A	L S H P V A
	Internal wall ⁱ	L S H P V A	L S H P V A	L S H P V A	L S H P V A	L S H P V A	L S H P V A	L S H P V A	L S H P V A
Yacht and Marine	Indoor floor	L S H P V A	L S H P V A	L S H P V A	L S H P V A	L S H P V A	L S H P V A	L S H P V A	L S H P V A
	Outdoor floor	L S H P V A	L S H P V A	L S H P V A	L S H P V A	L S H P V A	L S H P V A	L S H P V A	L S H P V A
Driveways**	Indoor flooring ⁱ	L S H P V A	L S H P V A	L S H P V A	L S H P V A	L S H P V A	L S H P V A	L S H P V A	L S H P V A
	Outdoor flooring ⁱ	L S H P V A	L S P V A	L S H P V A	L S H P V A	L S H P V A	L S H P V A	L S H P V A	L S H P V A

* Pay special attention to the friction coefficient in relation to the surface finish

** It is recommended to prefer the use of thicknesses of 20 mm and 30 mm

*** Bianco Angelica, Bianco Serena, Bianco Andromeda, Bianco Olimpia, Bianco Atena, Bianco Alba, Bianco Diana, Bianco Pandora, Bianco Vittoria, Bianco Giulia.

L: Lux S: Satin H: Lithos V: Vesuvio P: Velluto A: Arena

1.9. IDENTIFICATION LABEL

At the end of the production process, a unique ID label is attached to each slab, stating all the information regarding its production.

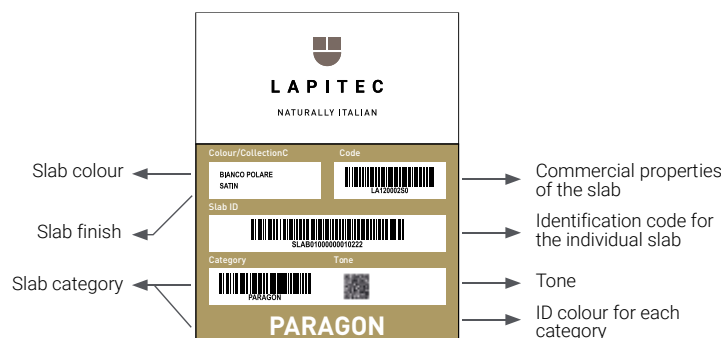

1.10. TESTING AND CERTIFICATIONS

ID	Certificate	Description
1	Technical sheet	Lapitec Product Description and Technical Data
2	Safety data sheet	Lapitec safety data sheet - REACH Reg.(CE) n.1907/2006
3	ISO 9001	Quality Management System
4	ISO 14001	Environmental Management system
5	BRE Test Report	Lapitec mechanical performances
6	FIRE REACTION	A1 as per EN 13501-1
7	EPD	Environmental Product Declaration as per EN15804
8	LCA	Life Cycle Assessment of Lapitec material as per EN15804
9	GREENGUARD/ GREENGUARD GOLD	Low Chemical Emission Certificate
10	HPD	Health Product Declaration
11	SILICA FREE	Silica free Laboratory Certificate
12	NSF	Food Equipment Standard certificate as per NSF/ANS 51
13	ANTI-SLIP PERFORMANCES	Performances as per EU and USA Standards
14	SRI INDEXES	Values of Solar Reflectance as per ASTM E903, ASTM E11980, ASTM C1371
15	CE MARKING	Declaration of Performance pursuant to EAD 090142-00-0404 for Sintered Stone.

1.11. CUT TO SIZE

1.11.1 MODULAR FORMATS

Upon request, Lapitec slabs can be supplied in modular formats, which can be used in different combinations.

The proposed formats are suggestions as to how to optimise the factory sizes of Lapitec slabs; please remember that the slabs can be cut and used in any other format required.

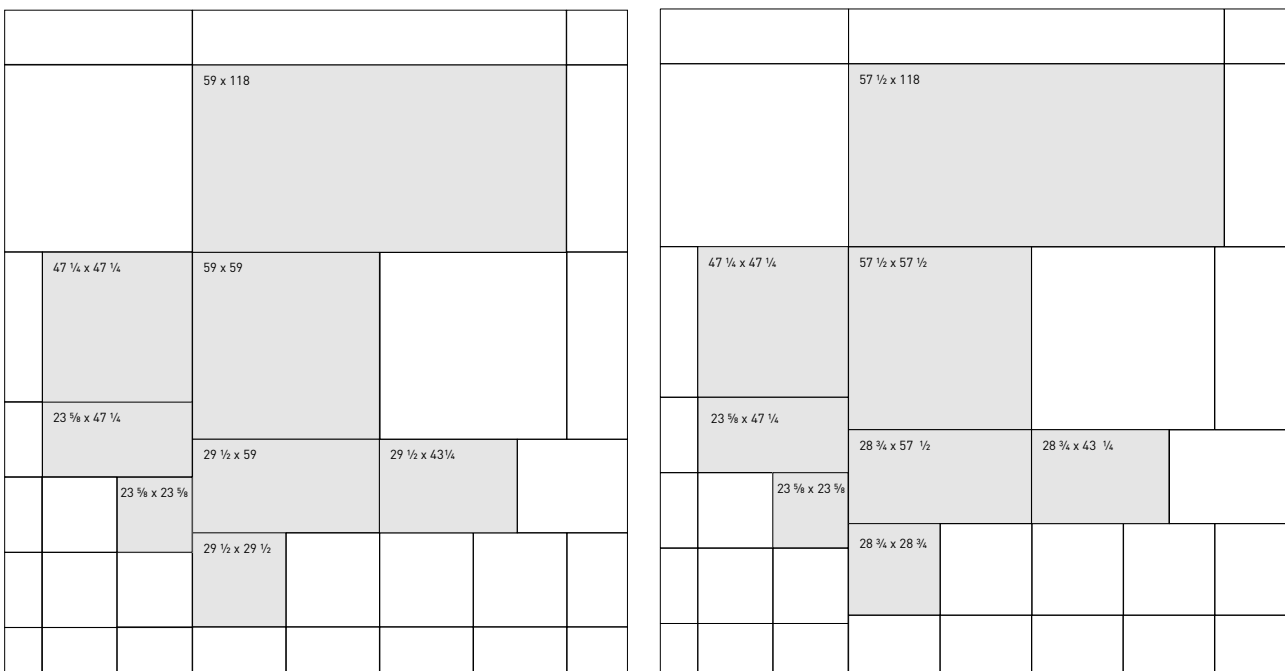

Note: The above dimensions are nominal. Refer to the design drawings for the corresponding processing dimensions. The actual dimensions may deviate from the processing dimensions by the corresponding tolerance given in the following paragraph.

1.11.2 WORKPIECES TOLERANCES

ITEM	Description	Tolerances	
		Unit of measurement	
Thickness	1/2"	inch	-0 / +1/32
	3/4"	inch	± 1/64
	1 1/4"	inch	± 1/64
Face size	Face dimension of pieces with length up to 6' 6 3/4"	inch	± 1/16
	Face dimension of pieces with length over 6' 6 3/4"	inch	± 3/32
Flatness	Maximum deviation from flat plane – width	inch / foot	1/64
	Maximum deviation from flat plane – length	inch / foot	1/64
Edge conditions	Bevels		-0/+25%
	Bullnose, semi-bullnose & rounds	inch	± 1/32
Squaring	Maximum deviation from right angle	Depends on the workpiece dimensions. Refer to image	

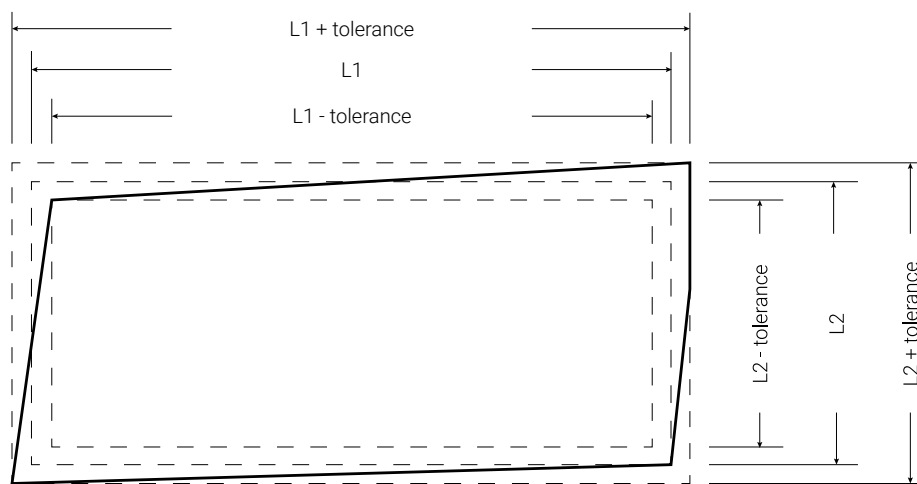

If the perimeter of the workpiece is contained between the rectangle of the larger tolerances and the rectangle of the smaller tolerances, the workpiece is considered acceptable.



2. PACKAGING AND HANDLING

2.1. PACKAGING

For all wooden packaging, Lapitec S.p.A. uses only fumigated wood

2.1.1 WOODEN BUNDLE



Overall dimensions	Empty bundle weight
137 ⁵ / ₁₆ x 22 ¹ / ₁₆ x h. 74 ¹³ / ₁₆ "	176,4 lb

The table below shows the characteristics of the bundles loaded with slabs of the same thickness. The values given below are purely indicative.

	U.M.	values for 1/2"-thick slabs	values for 3/4"-thick slabs	values for 1 1/4"-thick slabs
slabs per bundle	nr.	20	12	8
full bundle weight	lb	Approx 7893	Approx 7452	Approx 7231

Handling

Lapitec S.p.A. uses a special pallet truck with longer forks and an anti-tipping device (1) capable of transporting 2 bundles at the same time.

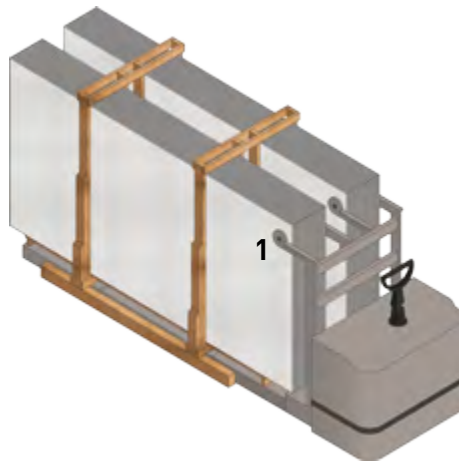

The bundles are only suitable for loading on containers open at the back (box, open top). To prevent the risk of damage from tipping, Lapitec S.p.A. secures the bundles using special air bags (1) and wooden straps fixed to the container walls (2) and, when necessary, safety belts (3).

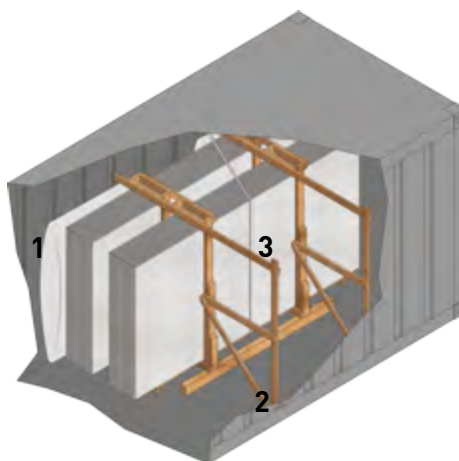

For the unloading of the bundles, additionally to the pallet truck described above, there are also devices on the market that can be used with normal lifting equipment (cranes, forklifts, overhead cranes).

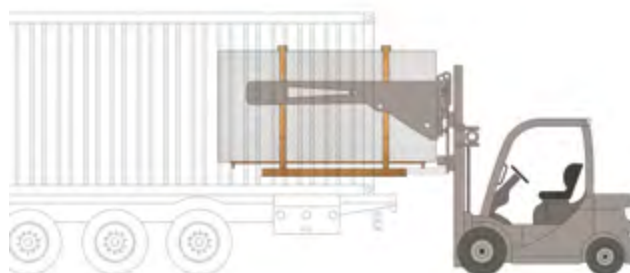
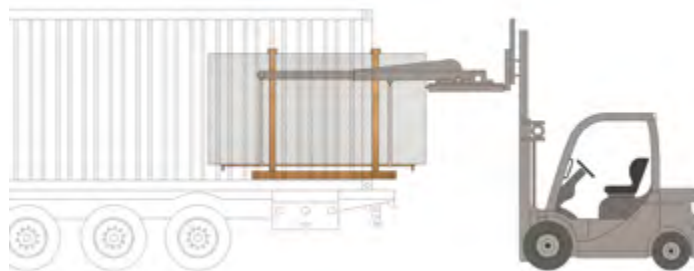

In the case of open top containers, the systems described above can be used, as well as overhead cranes or cranes with the lifting systems described in the following section: Handling of slabs.

If you want to unload one bundle at a time, you need to cut the central straps with a chainsaw, as indicated in the figure (sequence A, B, C).

Once the bundle has been divided, the packs must be harnessed individually to unload them.

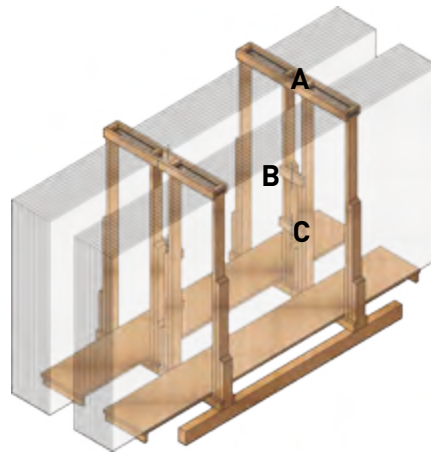

The pair of bundles is usually secured at the top with 3 pairs of straps:

2 pairs of straps secure the posts of the individual strap. It is important that these straps remain intact until the harnessing of the individual slab packs, otherwise the bundle becomes unstable and the slabs may slip.

1 pair of straps holds the two bundles together. These straps will be cut together with the main strap at the time of cutting indicated by the letter A in the figure above.

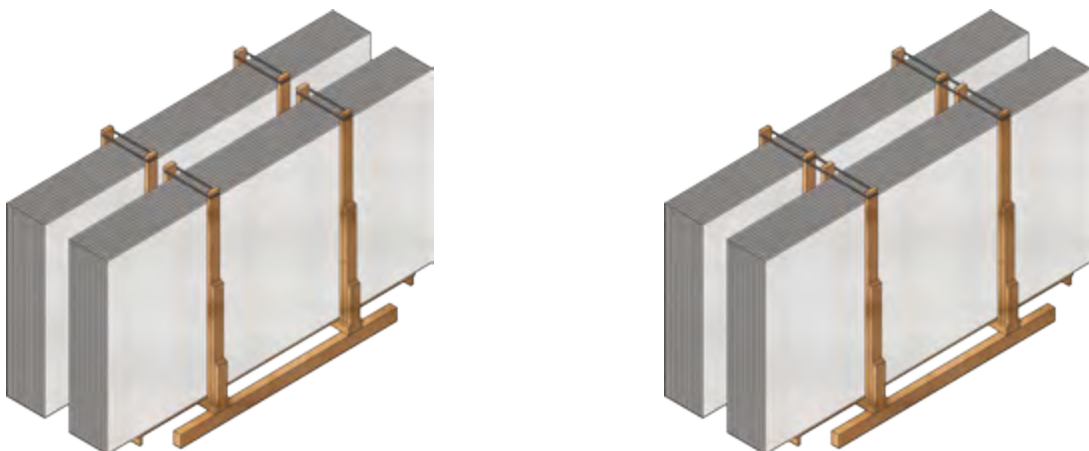

Loading on container

The table below shows the quantity of slabs of the same thickness that can be loaded on 20 ft and 40 ft containers with bundles.

The values given below are purely indicative.

CONTAINER 20' / 40'	U.M.	values for 1/2"-thick slabs	values for 3/4"-thick slabs	values for 1 1/4"-thick slabs
Total loadable bundles	nr.	7	7	7
Total slabs per container	nr.	140	84	56
Total weight with packaging	lb	Approx 55248	Approx 52161	Approx 50618

Note:

The weight limits imposed by the port of destination and the final destination must be considered when organising a container.

2.1.2 WOODEN A-FRAME



Overall dimensions	Empty A-frame weight
137 ⁵¹ / ₆₄ X 46 ¹⁵ / ₁₆ X h.72 ²⁷ / ₃₂	397 lb

The table below shows the quantity of slabs of the same thickness that can be loaded on the wooden A-frames. The values given below are purely indicative.

	U.M.	values for 1/2"-thick slabs	values for 3/4"-thick slabs	values for 1 1/4"-thick slabs
slabs per wooden A-frame	nr.	20	12	8
full wooden A-frame weight	lb	Approx 8113	Approx 7672	Approx 7452

The entire packaging consists of:

- 4 cardboard protections for the vertical sides of the slabs (1);
- 6 cardboard protections to be placed between the fixing straps and the slabs (2);
- 2 pieces of wood secured to the lower part of the A-frame by 2 screws, to prevent the slabs coming loose from the base (3);
- 3 fixing straps to secure the slabs to the A-frame;
- 1 polyethylene covering to protect the surface of the slabs (5);



Handling:

The A-frame can be transported using a forklift or by lifting with straps and sling bar, taking care to use rigid crossbars underneath the A-frame, between the straps and the A-frame itself.

The A-frames supplied by Lapitec S.p.A. are usually 4-way, meaning they can be lifted by a forklift from any of the 4 sides.

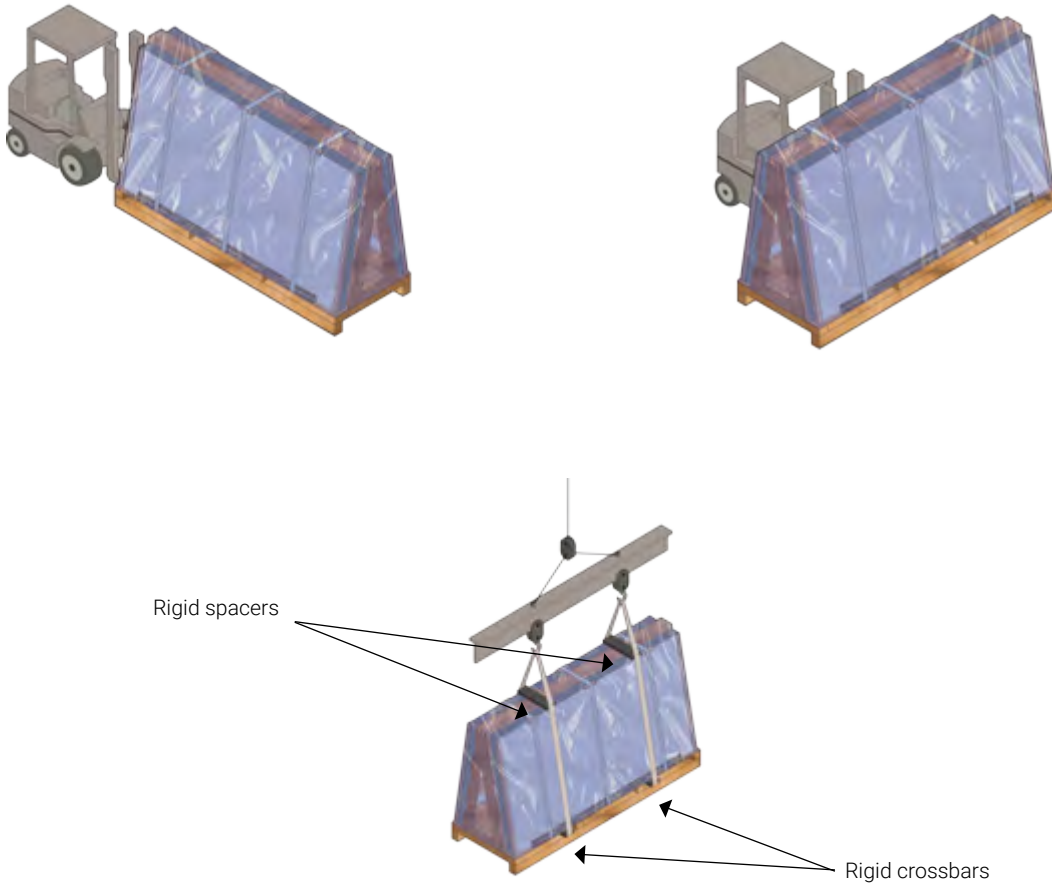

The wooden A-frames are ideal for loading on trucks, containers and by air.

Two suitably tensioned straps (1) are used to secure the A-frame to the truck floor.

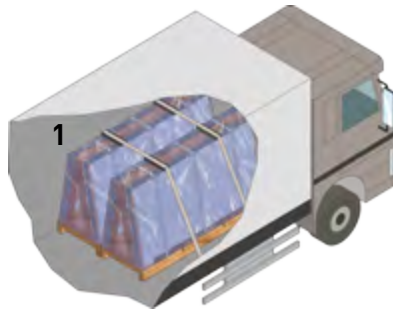

To secure the A-frame inside a container, wedges are placed on the sides of the A-frame as shown below (1).

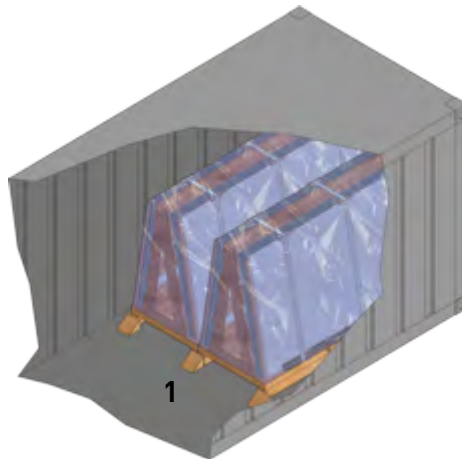

Loading on container

The table below shows the quantity of slabs of the same thickness that can be loaded on 40 ft containers with straps. The values given below are purely indicative.

CONTAINER 40'	U.M.	values for 1/2"-thick slabs	values for 3/4"-thick slabs	values for 1 1/4"-thick slabs
Total loadable wooden A-frames	nr.	6	6	6
Total slabs per container	nr.	120	72	48
Total weight with packaging	lb	Approx 48678	Approx 46032	Approx 44710

NOTE:

The weight limits imposed by the port of destination and the final destination must be considered when organising a container.

2.1.3 PAIRS OF STEEL A-FRAMES



Overall dimensions	Weight of empty pair of steel A-frames
137 ⁵ / ₆₄ x 94 ¹ / ₂ x h.59 ¹ / ₁₆	232 lb

The table below shows the quantity of slabs of the same thickness that can be loaded on a pair of steel A-frames. The values given below are purely indicative.

	U.M.	values for 1/2"-thick slabs	values for 3/4"-thick slabs	values for 1 1/4"-thick slabs
slabs per pair of steel A-frames	nr.	Approx 80	Approx 48	Approx 32
weight of pair of steel A-frames with slabs	lb	Approx 31096	Approx 29332	Approx 28451

Handling:

The steel A-frames are only suitable for loading on trucks. The steel A-frames are positioned manually on the truck floor at a wheelbase of approximately 70 ⁷/₈" - 78 ³/₄".

Once positioned, the A-frames are covered with wooden slats on both the base and the back to prevent the slabs from resting directly on the steel. Packs of slabs separated by 1 1/4"-thick wooden slats are then placed on the A-frames.

Each pack usually consists of 20 x 1/2" slabs, 12 x 3/4" slabs or 8 x 1 1/4" slabs so that the packs be easily moved from the crane.

The packs of slabs are loaded by crane or overhead crane from above, so the truck must have an openable roof. The average weight of each pack is 7275 lb.

The pair of A-frames with the slabs is secured to the truck with 5 suitably tightened straps:

- 2 straps are used to secure all the slabs on the A-frames (1).
- 1 strap secures the front of the slabs in the direction of travel, to prevent the load from slipping when braking (2).
- 2 straps secure the pair of A-frames to the trailer floor to prevent overturning (3).

The straps must be made of fabric, conform to EN 12195-2 and come complete with tighteners (see photo).



It is the transporter's responsibility to provide suitable straps and use them according to the strap supplier's instructions.

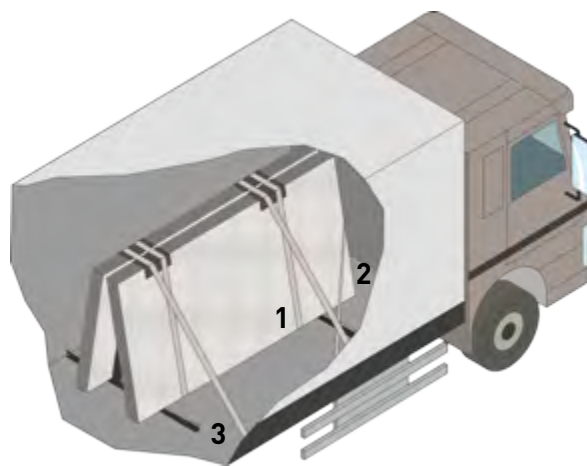

The A-frames must not be secured to the trailer floor using screws and nails. This is to prevent damage to the trailer's pneumatic system.

The A-frames must be placed on non-slip mats to increase the grip between the A-frame and the trailer floor.

Wooden shims (about $1\frac{9}{32}$ " thick) should be placed under the A-frames to allow the passage of the unloading belts.

If the packs of Lapitec® slabs need to be placed on A-frames already containing slabs made from other materials, it is the transporter's responsibility to check that the packs of Lapitec slabs are not placed on other packs of slabs with a lower height.

Under no circumstances should steel chains or ropes be used as these may ruin the material.

2.1.4 NON-STANDARD PACKAGING: CRATES, PALLETS, ETC.



Dimensions	Weight
Variable	Variable

Crate and pallet packaging is only used when supplying workpieces that are cut to size and sized according to individual project requirements.

The crates supplied by Lapitec S.p.A. are generally 2-way. In special cases or on request they can be 4-way.

Handling:

The crates can be moved by forklift or pallet truck.

The crates are ideal for loading on trucks, containers and by air.

Crate opening:

To prevent the workpieces from overturning when opening the crate, tilt it slightly by placing wedges on the opening side (see diagram).

To open the crates, Lapitec S.p.A. marks in red the screws that are to be unscrewed. Removing these screws will allow the crate to be fully opened.

The handling of workpieces inside the crate should be done manually or using equipment (see following sections) depending on the dimensions of the individual piece or according to requirements.



2.2. HANDLING OF SLABS

The slabs should always be handled from the side to prevent bending, and with the utmost care and attention to prevent chipping and breakage of the material.

Operators should avoid any type of impact on the slabs. In the event of accidental impact, it is necessary to check that there is no breakage or cracks. This check is important because any cracks may cause breakage even after laying.

Lapitec must always be handled using gloves to prevent any cuts and deposits of dirt on the slab.

2.2.1 MANUAL HANDLING

Any format exceeding 55 lb and in general any long-sized format must be handled by two operators.

2.2.2 HANDLING WITH EQUIPMENT

Slabs can be moved individually using rubber-coated canvas straps, rubber grippers or suction cups. Under no circumstances should steel chains or ropes be used as these may ruin the material.

To grip the individual slab, it is recommended to position the gripper at the load centre to balance the weight and minimise oscillations (as shown in figure 1). When putting down a slab with the gripper, make sure that between what is being positioned and the support (other slab or floor) there are no empty spaces.

To grip multiple slabs, it is recommended to use a balancing frame connected to canvas straps spaced on the bottom and on top of the slabs by a wooden shim slightly longer than the slab pack (as shown in figure 2). In this way, the stress exerted during handling does not weigh on the slabs, preventing material breakage.

Handling using suction cups is permitted (as shown in figure 3), subject to verification of compatibility with the roughness of the surface.

Before proceeding, always ensure that the load to be handled is within the maximum capacity of the lifting equipment.

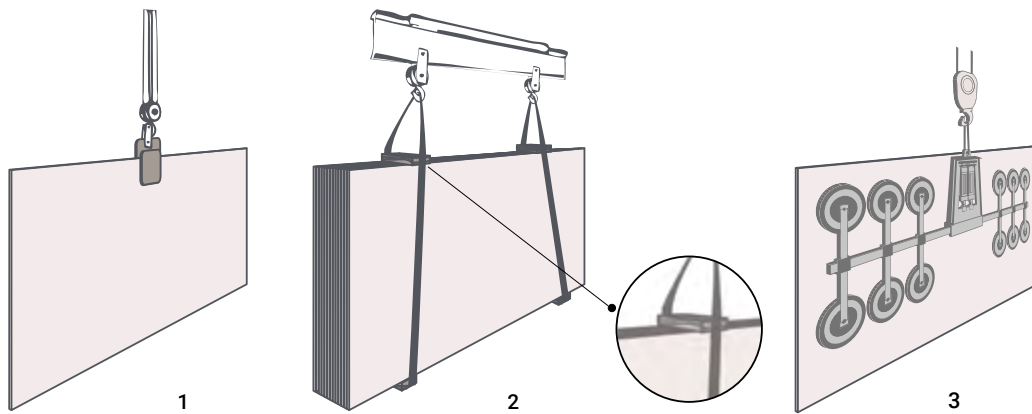

2.3. SLAB INSPECTION

We recommend that our customers carefully clean and inspect each slab before use. This ensures that the product can be used in the best way possible and allows for checks into compliance with all quality standards.

Please note: this should be standard practice. Complaints will not be accepted regarding material that has been installed with defects that were already present at the time of delivery.



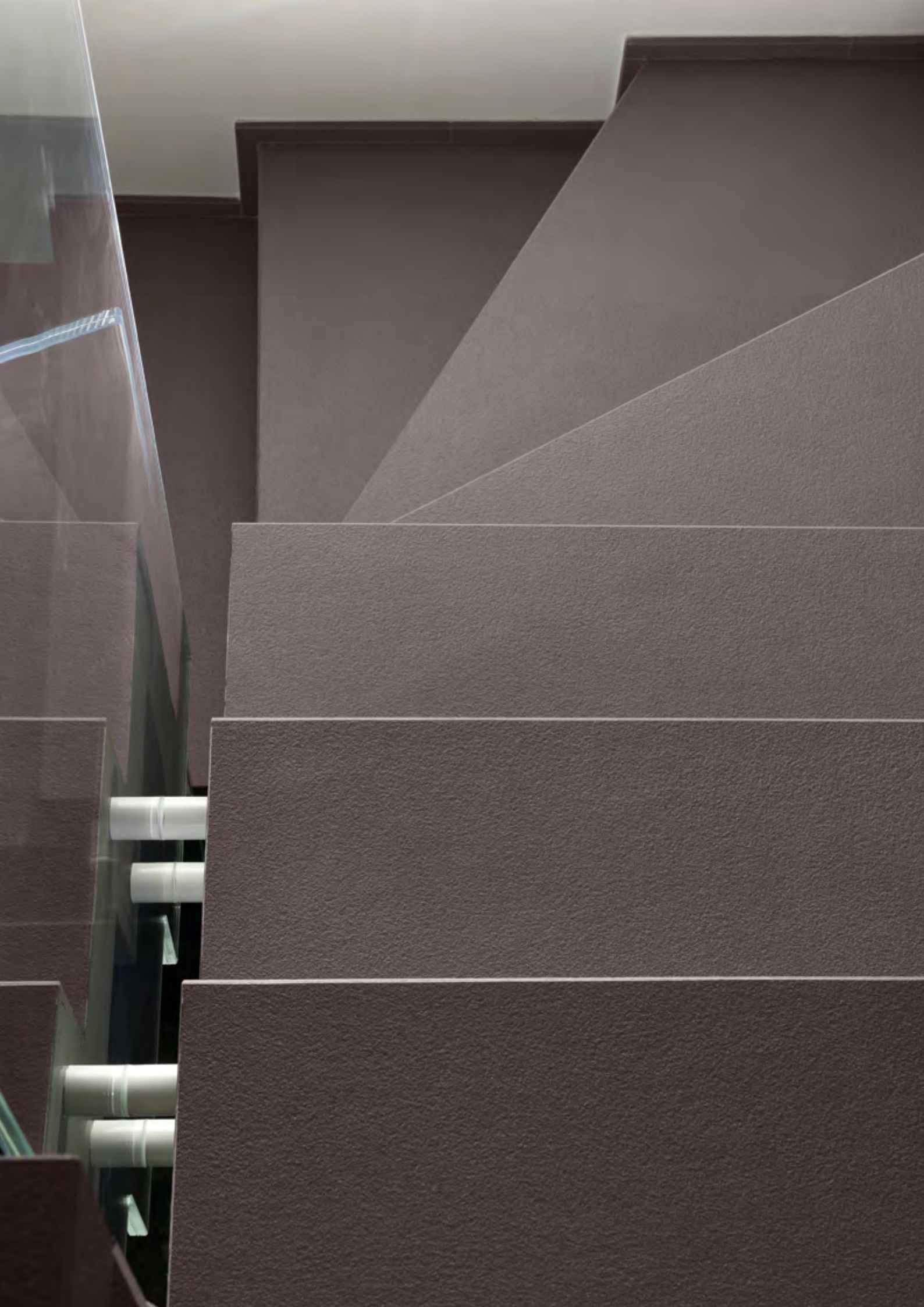

3. CUSTOMER CARE

Lapitec Academy

Lapitec Academy provides training and support for professionals who work with Lapitec®, by organising in-house training courses and offering direct assistance. Lapitec S.p.A. uses all the experience it has developed through the numerous international projects and different applications completed to date in order to perfect its products and accessories.

By liaising directly with customers, Lapitec S.p.A. continuously researches new solutions to make its service even more complete and effective, meeting all the various requirements for use.

Thanks to the Academy Community service, any new features and technical developments can be promptly shared with the entire network of partners.

By attending the Lapitec Academy training course, professionals can obtain 'Approved Fabricator' certification, as well as learning useful tips and techniques for working with Lapitec.

Contacts:

academy@lapitec.com

+39 0423 703811



Customer Care

Please don't hesitate to contact the Lapitec S.p.A. customer care team for any information you may need.

Contacts:

customercare@lapitec.com

+39 0423 703811



LAPITEC

NATURALLY ITALIAN

Lapitec S.p.A.
via Bassanese, 6
31050 Veduggio (Treviso) Italy
tel. +39 0423 703811
fax. +39 0423 709540
info@lapitec.com - www.lapitec.com